

EasyPet®

EP-380R User's Manual

Rechargeable Multi-Dog Remote Training System

Advanced Model of 1200 Meter Remote Range

Fully Waterproof & Submersible Collar Receiver

Compact, Lightweight, and Convenient!

EasyPet[®] EP-380R User's Manual

Rechargeable Multi-Dog Remote Training System

Advanced Model of 1200 Meter Remote Range

Fully Waterproof & Submersible Collar Receiver

Compact, Lightweight, and Convenient!

Please read this manual thoroughly and carefully before operating.

Thank you for purchasing our EasyPet[®] EP-380R remote dog training system. This is an effective multi-dog training system (extra receivers required), which provides all of the features for reliable, safe and humane training you want in a companion dog trainer. It features an easy-to-use rechargeable transmitter with large LCD display, rechargeable and fully waterproof collar receiver, 50 groups of warning tones, 10 levels of vibration corrections, 99 levels of static pulse stimulation corrections and 1200 meter remote range (in open area).

Main Features:

- Can train up to 3 dogs from 1 transmitter (extra receivers required);
- Remote range up to 1200 meters (in open area);
- Rechargeable transmitter handset;
- Rechargeable & fully waterproof collar receiver. It is a heavy duty collar receiver with quality TPU collar strap and suitable for outdoor activities;
- 3 Correction modes: warning tone (50 groups) & vibration (10 levels) & static pulse stimulation (99 levels);
- Large LCD display with backlight for easy training;
- Low battery indicator on both transmitter and receiver;

Contents:

- 1 x Rechargeable transmitter handset with large LCD display;
- 1 x Rechargeable collar receiver with two sets of correction prongs (in different length) & 1 x quality TPU collar strap (You can also use your own strap as long as it does not exceed 2mm in thickness & 17mm in width);
- 1 x Test bulb for testing static pulse stimulation correction - normally packaged with longer prongs in a small plastic bag (for testing purpose only, not to be used when the collar receiver is on the dog);
- 1 x Charger power plug (output 5V DC 1A);
- 1 x User's manual (English).

How the System Works

Consistent and correct use of this remote dog trainer allows you to reinforce commands and correct misbehaviour from up to 1200 meters (in open area). There are 50 groups of warning tones that can be used for praise, warning or silent recall. Or use the remote transmitter to send a signal, activating the collar receiver to deliver a vibration correction or a harmless stimulation. It has 10 levels of vibration corrections and 99 levels of static pulse intensity so you can find the best level for your dog's temperament and the type of training you do.

Important: This remote dog training system has a range of up to 1200 meters in open area. Depending on the way you hold the remote transmitter, the maximum range may vary. For consistent results at longer ranges, hold the remote transmitter in a vertical position away from your body and above your head. Terrain, weather, vegetation, transmission from other radio devices, and other factors will affect the maximum range.

More Information about Correction Modes

Warning Tone Correction: There are 50 groups of warning tones in different frequencies. Each warning tone is about 2 second long beeping in different frequency. These can be used for praise and warning for your dog.

Vibration Correction: There are 10 levels of vibration corrections. Level 1 is the weakest one and level 10 is the strongest one. These can be used for silent warning or recall.

Static Pulse Stimulation Correction: There are 99 levels of static pulse stimulation corrections. They are divided into 10 different groups of intensity (from mildest to strongest). Each correction group is again divided into 10 types of correction with different correction durations (from 200ms/0.2 second to 2 seconds. Within the same group, each higher level will have about 0.2 second increased on correction duration).

For example, Level 1 has the mildest static pulse stimulation intensity and the shortest correction duration (200ms/0.2 seconds), Level 2 will have the same intensity as Level 1 but the correction duration will be about 0.4 second - about 0.2 second longer than Level 1. While at Level 10, it still has the same mildest static pulse intensity (same as Level 1) but with the longest correction duration (2 seconds).

From Level 11, the intensity will be increased to a slightly higher level than the one of Level 1 to Level 10, and the correction duration again is back to the shortest one (200ms/0.2 second), while Level 20 will have the same intensity as Level 11 but has the longest correction duration (2 seconds).

From Level 90 to Level 99, it has the strongest static pulse stimulation intensity again with different correction durations (from 200ms/0.2 second to 2 seconds).

Quick Start Guide

Step 1: Prepare the Remote Transmitter Handset

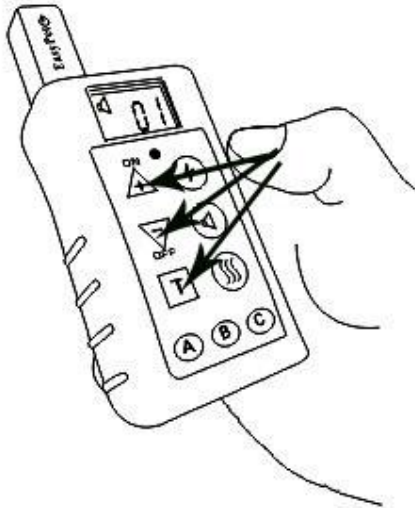

- Press and hold down the ON button for 3 seconds to turn on the transmitter
- Press and hold down the OFF button for 3 seconds to turn off the transmitter
- Short press T button to send out a command to the collar receiver

The transmitter handset should normally have battery power left and you can start using it without putting it on charge first.

To switch on the transmitter, press and hold ON button (+) on the transmitter for 3 seconds. To switch it off, please press and hold OFF button (-) for 3 seconds.

If battery status bar shows empty bar on LCD display, it means the battery is running down and please charge the transmitter with the supplied charger plug immediately. When the battery is low, the LCD backlight will flash three times whenever the "T" button is pressed, to prompt the you to charge the transmitter.

Charging the Transmitter: Plug the supplied wall charger into the wall socket and into the charger port of the transmitter which is located at the bottom part of the transmitter handset. If the transmitter handset is switched off, please turn it on during charging. The battery status bar on LCD display will start flashing with moving bars. When the battery status bar stops flashing with full bars showing, the transmitter is fully charged. The normal charging time for transmitter is around 4 hours, for new battery, it will take longer to get fully charged in the first few cycles. Please remove the power plug from the wall socket when the transmitter is fully charged.

Caution! Always use the supplied power adaptor to charge the transmitter. Do NOT charge the transmitter in an especially hot area. Do NOT leave charging unattended or charge overnight!

If the battery status bar shows full bars (i.e. 3 bars) and the transmitter is put on charge, the background light will come up shortly when the charger pin is inserted, but the battery status bar will not flash--this is normal as the battery is full and transmitter will not take charge in this case.

Transmitter Handset Buttons & Symbols Information:

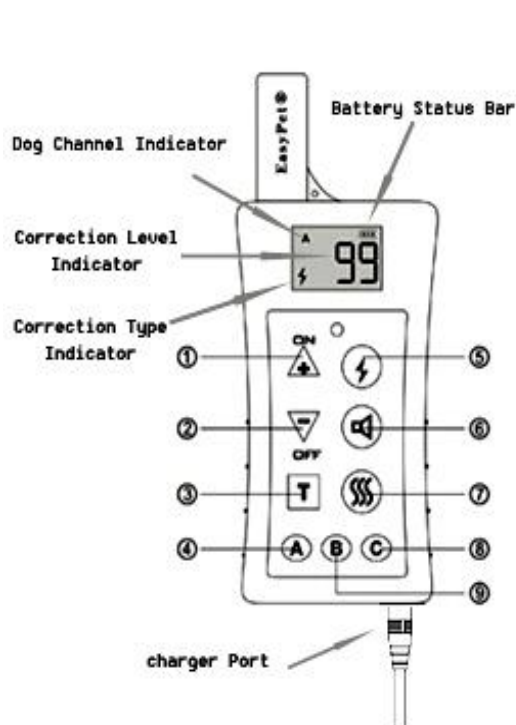

LCD Screen Info:

Battery Status Bar: Indicates the capacity of battery in the transmitter

Dog Channel Indicator (A, B or C): Indicates to which dog you are sending out command(s)

Correction Level Indicator: Indicates the level setting of the current correction mode

Correction Type Indicator: Indicates the current correction mode in symbols

Charger port: charger port is located at the bottom part of the transmitter

Buttons info:

1. ON button: hold down this button for 3 seconds to turn on transmitter
Or "+" button: Short press to increase the correction level setting
2. OFF button: hold down this button for 3 seconds to turn off transmitter
Or "-" button: Short press to decrease the correction level setting
3. T Button (Transmit button): Short press to send out a command of the current correction mode to the selected dog channel
4. Dog Channel A: Short press to select Dog channel A (for Dog A)
5. Static pulse stimulation button: Short press to choose static pulse stimulation mode
6. Warning tone button: Short press to choose warning tone mode
7. Vibration button: Short press to choose vibration mode
8. Dog channel C: short press to select dog channel C (for Dog C)
9. Dog channel B: short press to select dog channel B (for Dog B)

Detailed Information on Symbols & Buttons:

Battery Status Bar: This indicates the capacity of the battery in the transmitter handset (i.e. the remote control). When transmitter handset is fully charged, it will show three bars in full. As soon as the transmitter is used, it may drop to two bars, this is normal. It will stay in two bars for very long time. The average battery usage time for the transmitter handset is about one to two months before it needs a recharge.

Dog Channel Indicator: The indicators are displayed on the top area of the LCD screen in letter A, B or C. This indicates the current selected dog channel. Always check the dog channel before sending out a command. If a wrong channel is selected

(sometimes accidentally), the collar receiver will not receive the command sent out from the transmitter handset.

Correction Level Indicator: This indicates the level settings of the current correction mode.

If it displays "--" on the Correction Level Indicator (with no numbers), it means the transmit function on the transmitter is disabled temporarily: When in this "**No Transmit**" mode, transmitter will NOT send out any commands even if T button (transmit button) is pressed. This feature is to avoid the T button (transmit button) to be pressed by accident during a walk or a training session while the transmitter is turned on. **To enter this "No Transmit" mode,** simply press the current selected correction mode button once - or press any other correction mode button twice. **To quit this "No Transmit" mode,** simply press any correction mode button (button 5, 6 or 7 in the picture) once.

Correction Type Indicator: This indicates the current selected correction mode in symbols (Lightening symbol for static pulse stimulation mode. Speaker symbol for warning tone mode. Shaking symbol for vibration mode).

ON/OFF (+/-) Button(s): Press and hold down ON button for 3 seconds, this will turn on the transmitter handset. Press and hold down the OFF button for 3 seconds, this will turn off the transmitter handset.

When transmitter is ON, short press "+" or "-" button will adjust the correction level setting on selected correction mode. When the correction level is at the lowest setting (Level 1), short press "-" button once will change the level setting to the highest level of the selected correction mode. When the correction level is at the highest setting, short press "+" button once will change the level setting to the lowest level (Level 1) of the selected correction mode.

T Button (Transmit Button): Short press this button will send out a command of the current correction mode to the selected dog channel. The command is sent out as soon as this button is released (but not pressed down). The green signal indicator light on the transmitter handset will come up to indicate the command is being sent out to the selected dog channel. This indicator light will stay on for about 2 seconds, the transmitter handset will not take a new command during this period.

Correction Mode Buttons: These are buttons 5, 6 and 7 in the picture. Short press any of these buttons will allow you to select the correction mode (static pulse stimulation, warning tone, or vibration). You may short press on these buttons to select the correction mode to be used and then press T button to send out the command to the selected dog channel.

A, B, C (Dog Channel) Buttons: Short press on A, B or C button will allow you to choose the dog channel.

Step 2: Charge the Collar Receiver

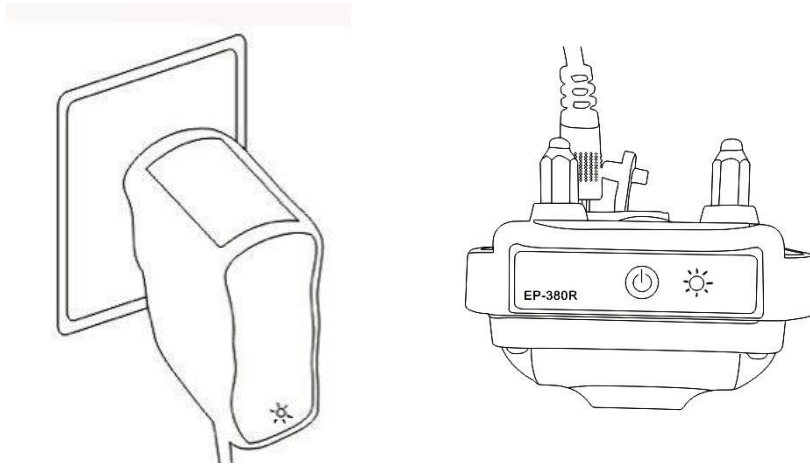

- **Normal charging time for collar receiver: around 2 to 3 hours**
- **To insert the rubber bung smoothly back into the charging port, please lift up the bung and make sure the rubber bung is in vertical position.**

Caution! Always use the supplied power adaptor to charge the collar receiver. Do NOT charge the collar receiver in an especially hot area. Do NOT leave charging unattended or charge overnight!

The system has been tested in factory. When you receives the product, the collar receiver might still have power left. You might skip this step and try to turn it on (please go to Step 3) and start using the system. If the collar receiver cannot be turned on, please put it on charge as following.

To charge the collar receiver, lift the small rubber bung on the receiver to access the charger port. Plug the supplied wall charger into the wall socket and into the charger port of the receiver. A red LED light on the collar receiver will come up and stay on during charging. When it is fully charged, the red LED light on the collar receiver will turn GREEN. Once the charger plug is removed from the wall socket, the LED light on the collar receiver will go off, the collar receiver will be turned on automatically after charging.

The normal charging time for the collar receiver is around 2 to 3 hours. For new battery, it might take longer to get fully charged in first few cycles. Please remove the charger from the collar receiver when it is fully charged.

Please cover the charging port with the rubber bung tightly after charging. To insert the rubber bung smoothly back into the charging port, please lift up the bung and make sure the rubber bung is in vertical position (as shown in the following picture).

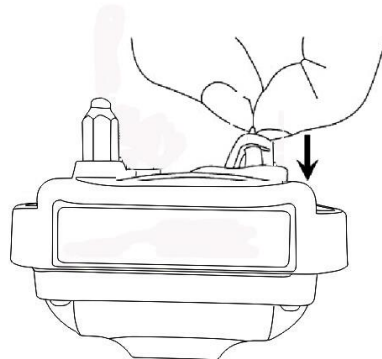

When the battery is low, the LED light on the receiver will flash red. Please charge the receiver as soon as possible.

Step 3: Turn ON/OFF the Collar Receiver

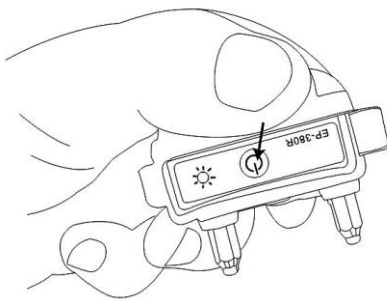

- Short press 3 times repeatedly on the POWER button (red light come up each time when button is pressed down), collar receiver will short beep once when it is turned on.
- Short press 3 times repeatedly on the power button (green light come up each time when button is pressed down), collar receiver will emit a long beep once when it is turned off.
- To tell whether the collar receiver is On or Off, simply short press power button once, if a GREEN light comes up, the receiver is On. If a RED light comes up, the

After charging, the collar receiver will be turned on automatically when the power plug is removed.

If you wish to manually turn on/off the collar receiver, simply follow the steps below:

Important: Due to the compact size of the collar receiver, the power button is designed in relatively small size, you might find it easier to press down the button with your finger nail at certain part of the power button symbol.

To turn on the collar receiver, short press the power button three times repeatedly within 3 seconds, a RED light will come up each time when the button is pressed down and go off when the button is released. The collar receiver will short beep once. The collar receiver is now turned on into working mode. It will respond to the commands sent from the transmitter handset if it is matched up properly in the selected dog channel.

To turn off the collar receiver, short press the power button three times repeatedly within 3 seconds, a GREEN light will come up each time when the button is pressed down and go off when the button is released. The collar receiver will emit a long beep once (for about 1 second). The collar receiver is now turned off into OFF mode. It will not receive any commands from the transmitter handset.

To tell whether the collar receiver is ON or OFF, simply short press the power button once, if a green LED light comes up when the button is pressed, it means the collar receiver is in working mode (ON). If a red LED light comes up when the button is pressed, it means the collar receiver is in OFF mode (OFF).

You can also tell from the length of the beep to see whether the collar receiver is ON or OFF. If the collar receiver gives a short beep when you are performing the turning ON/OFF procedures manually, it means the collar receiver is turned on. If collar receiver gives a longer beep when you are performing the turning ON/OFF procedures manually, it means the collar receiver is turned off.

The average battery usage time for the collar receiver is about 3 to 5 days before it needs a recharge. This will also depend on how often and what type of correction is used on the collar receiver.

To achieve longer battery life, please turn off the collar receiver when it is not used.

If the system is not going to be used for a long period of time, please do the following:

1. Fully charge both transmitter handset and collar receiver;
2. Switch both of them off properly;
3. Store them in a still and cool place.

Step 4: Match the Receiver with the Transmitter

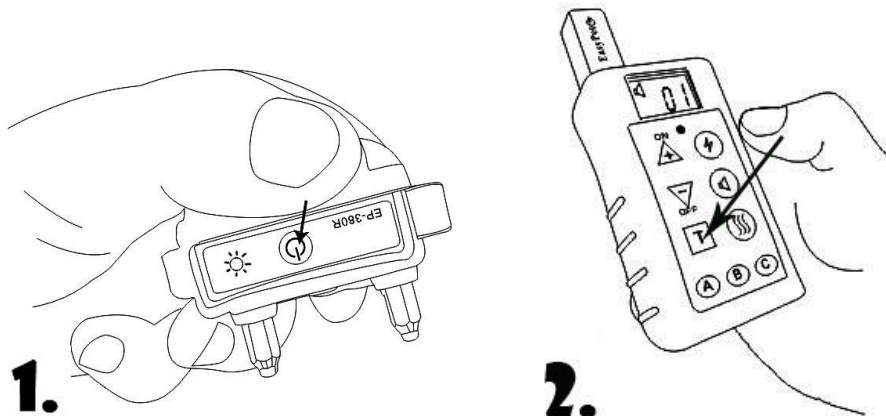

- Turn on both transmitter handset and collar receiver
- On the handset, choose a dog channel (A,B or C) for the collar receiver and select a correction mode and level setting
- Press and hold down the power button firmly on the collar receiver
- Short press T button on handset to send out a command
- The green indicator light on the collar receiver should start flashing on and off
- Matching up is done properly, you can release the power button on collar receiver

Collar receiver might have been matched up in to one of the channels on the transmitter handset when it is tested in factory. To check this, please turn on the transmitter handset and collar receiver, send a beep tone command to the collar receiver from A, B or C channel. If the collar receiver bleeps in one of the channels, the collar receiver has been registered to that channel properly. You do not need to carry out the following matching-up procedures and can start using the system through that registered channel.

If the collar receiver does not respond to the transmitter handset in any of the channels, or if you wish to change the registered channel for this collar receiver, **please follow the matching-up procedures below:**

4.1 Switch on the transmitter handset and then choose either A, B, or C dog channel (Note: this will be your registered channel for the collar receiver). Choose a correction mode and a correction level setting - any correction mode (static pulse stimulation, vibration or warning tone) and level can be used for the matching-up, as

long as correction level indicator is not shown as "--" on the LCD screen (which is the "No Transmit" mode for the transmitter).

4.2 Make sure the collar receiver is turned ON. (The collar receiver will be turned on automatically after the charging or please refer to Step 3: Turn ON/OFF the Collar Receiver) .

4.3 Press and hold down the power button on collar receiver firmly (you might find it easier to hold it down firmly with finger nail), a green indicator light should come up and stay on in the collar receiver while the button is pressed down (Please note that the power button needs to be held down firmly until the matching up is completed).

4.4 Short press the "T" button on transmitter handset. The green indicator LED light on the transmitter will come up, which means it is sending out a command to the collar receiver. On the collar receiver, the green LED light will start flashing on and off (it will be a proper on and off flashing but not just a flickering) which indicates the matching-up procedure is completed successfully.

4.5 You may now release the power button on the collar receiver and start using the collar receiver from the registered channel.

If you find it difficult to hold down the power button on collar receiver properly during the whole matching up procedure, you might find the following way easier to perform the matching up:

With both transmitter handset and collar receiver turned on, send out a correction command from the transmitter handset by short pressing the T button on the handset. The handset will send out a command to the collar receiver and the signal will last for 2 seconds. **WITHIN THESE 2 SECONDS**, press and hold down the power button on collar receiver firmly (you might find it easier to hold it down firmly with finger nail), the green LED light on collar receiver will come up and start flashing on and off. You may now release the power button on collar receiver and the matching up is completed.

For multi-dog training setup, simply follow the above matching-up procedures to match up the collar receivers one by one. Each time, choose a different dog channel for the new collar receiver.

The matching code will be stored in the receiver automatically and there is no need to repeat the matching procedures after switching on/off or recharging the collar receiver. *

** If the battery inside the collar receiver has been left flat for a long period of time, the collar receiver might lose the matching code memory. Please charge the collar receiver and perform the matching-up procedure again.*

Caution! Never perform the matching-up procedures while the collar receiver is on your dog!

Step 5: Test the Collar Receiver

Important: We would recommend you to use warning tone or vibration correction first before starting the static pulse stimulation. And always start at the lowest level of stimulation and work your way up.

Please make sure the collar receiver is in fully working order before putting it on your dog!

Let's take Dog A collar receiver for example:

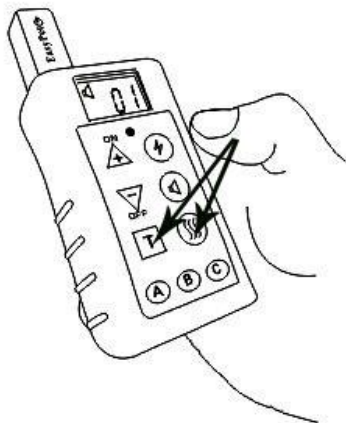

Send vibration correction command to collar receiver:-

- **Short press vibration button and select a valid correction level setting**
- **Short press T button and a vibration command will be sent out to the collar receiver when T button is released**

To test the vibration function, short press the vibration button  on the transmitter and choose a valid correction level for vibration (from Level 1 to Level 10, Level 1 is the weakest and Level 10 is the strongest)

Short press button **T** to send out command to Dog A collar receiver. Dog A collar will start vibrating for about 2 seconds at the selected level. A green LED light on the collar receiver should come up during this correction period.

Short press "+" or "-" to adjust the level setting of vibration correction. Short press button **T** again to send out the new command. Dog A collar will start vibrating at the newly selected level. A green LED light on the collar receiver should come up during this correction period.

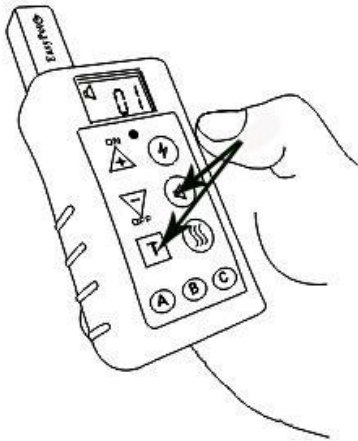

Send warning tone correction command to collar receiver:-

- Short press warning tone button and select a valid correction level setting
- Short press T button and a warning tone command will be sent out to the collar receiver when T button is released

To test the warning tone function, short press the warning tone button  on the transmitter and choose a valid correction level for warning tone correction. There are 50 groups of warning tones in different frequencies. (You can choose the desired groups for your dog for different praise and warning purposes.)

Short press button T to send out command to Dog A collar receiver. Dog A collar will start bleeping for about 2 seconds at the selected level. A green LED light on the collar receiver should come up during this correction period.

Short press "+" or "-" to adjust the level setting of warning tone correction. Short press button T again to send out the new command. Dog A collar will start bleeping at the newly selected level. A green LED light on the collar receiver should come up during this correction period.

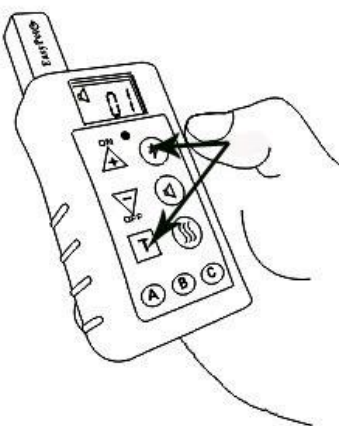

Send static pulse stimulation command to collar receiver:-

- Short press static pulse stimulation button and select a valid correction level setting
- Short press T button and a static pulse stimulation command will be sent out to the collar receiver when T button is released

To test the static pulse stimulation, short press the static pulse stimulation button  on the transmitter and choose a valid correction level for static pulse

stimulation. When trying this on your dog, please always start from the LOWEST level and increase the level gradually to find out the recognition level for the dog.

Short press button **T** to send out command to Dog A collar receiver. Dog A collar will start giving a static pulse stimulation at the selected level. A green LED light on the collar receiver should come up during this correction period.

Short press "+" or "-" to adjust the level setting of static pulse stimulation. Short press button **T** again to send out the new command. Dog A collar will start the static pulse stimulation at the newly selected level. A green LED light on the collar receiver should come up during this correction period.

To test if the static pulse stimulation is working, attach the supplied test bulb to both of the metal prongs on the collar receiver. The test bulb should start flashing when the collar receiver is giving out static pulse stimulation. (Please note the test bulb is for test purpose ONLY. When the collar receiver is used on the dog, please remove the test bulb from the collar receiver.)

Tips: When on Level 99, you can quickly press plus "+" button once to go back to Level 1. When on Level 1, you can quickly press minus "-" button once to increase to Level 99.

Note: For multi-dog training, please select the dog you would like to train by pressing A, B or C button. When LCD screen is showing the correct dog selected, then follow the above procedures to send out correction commands.

Step 6: Fit the Collar Receiver on the Dog

To ensure a proper fit, please follow the steps below:

1. With your dog standing, centre the collar receiver where contact points are underneath your dog's neck, touching the skin. If your dog has a long or thick coat, trim the hair around the contact points to ensure consistent contact.
2. The collar receiver should fit snugly, yet loose enough to allow one finger to fit between the strap and your dog's neck. If the strap is too long for your dog, cut off the excess length.
3. Allow your dog to wear the collar for several minutes, and then recheck the fit. Check the fit again as your dog becomes more comfortable wearing the collar receiver.

Important:

1. The proper fit and placement of the collar receiver is important for effective training. The contact points must have direct contact with your dog's skin. Trim the fur if necessary.
2. Please note that the collar receivers are not designed to be worn continuously by a dog. To prevent irritation caused by rubbing, remove the collar for at least 8 hours out of every 24-hour period.
3. Please note that our collars are designed for remote training purpose only. Never attach a leash onto the collar. Use a separate collar strap if needed.

Care and Cleaning

To ensure the effectiveness of this product and the comfort and safety of your dog, check the fit of his collar frequently. Your dog's neck and the contact points must be washed weekly with a wash cloth and mild hand soap, and then rinsed thoroughly. If you notice that your dog is experiencing skin irritation, discontinue use of the collar for a few days. If the condition persists over 48 hours, consult your veterinarian.

Find the Best Intensity Level for Your Dog

This remote training system has multiple intensity levels. This allows you to choose the stimulation that is best for your dog. Always start at the lowest level and work your way up. For training efficiency, it is important to find the right intensity level for your dog. This is called Recognition Level, at which your dog looks around in curiosity, or flicks his ear.

Finding Your Dog's Recognition Level:

Every dog is different and you cannot predict where your dog's Recognition Level will be. Watch closely for any slight change in behaviour that tells you your dog is feeling the stimulation.

1. With the collar receiver turned on and properly fitted to your dog, select static pulse stimulation level 1 and press T button to send out signal.
2. If your dog shows no reaction to Level 1, then gradually increase the intensity level by short pressing plus "+" button.
3. YOUR DOG SHOULD NOT VOCALIZE OR PANIC WHEN RECEIVING STIMULATION. IF THIS HAPPENS, THE STIMULATION LEVEL IS TOO HIGH AND YOU NEED TO GO BACK TO THE PREVIOUS LEVEL AND REPEAT THE PROCESS!
4. Once you find your dog's Recognition level, this is the level you should use when you begin a training exercise. (The selected level will be stored in the transmitter automatically.)

5. If you have progressed to Level 99 while searching for your dog's Recognition Level and your dog continues to show no response, check to see if collar receiver is snug against your dog's neck. Then go back to Intensity Level 1 (button 1) and repeat the process. If your dog still does not indicate he is feeling the stimulation, you may have to trim the hair beneath the contact points.

General Training Tips

Please keep the following training tips in mind.

- Eliminate one misbehaviour or teach one obedience command at a time. If you move too fast with the training, your dog may become confused.
- Be consistent. Give your dog a tone or a vibration or stimulation with each misbehaviour.
- Do not overcorrect your dog. Use as few stimulation as possible to train your dog.
- Restrict your dog from situations in which he has a history of misbehaving unless you can supervise him and use the remote training system for applying tone , vibration or stimulation corrections.
- If you notice one situation in which your dog misbehaves repeatedly, set up this situation as a training session. This will dramatically increase your chances of success.
- If your dog has a timid reaction to the tone or vibration or stimulation (especially the first couple of times), do not be alarmed. Redirect his attention to a simple and appropriate behaviour (i.e. a known command, such as "Sit").
- Never use the remote training system to correct or eliminate any form of aggressive behaviour. If your dog exhibits such behaviour, contact a professional trainer. Aggression in dogs is the result of many factors-it may be a learned behaviour or it may be brought on as a result of fear. Another factor contributing to aggression in dogs is social dominance. Every dog is different.
- Only use this training system on healthy dogs of at least 6 months old.

Frequently Asked Questions

Q1: Is the stimulation safe for my dog?

A: While the stimulation is unpleasant, it is harmless to your dog. Electronic training devices require interaction and training from the you to achieve desired results.

Q2: How old does a dog have to be before using the remote training system?

A: Your dog should be at least 6 months old and in healthy conditions. Your dog should be able to learn basic obedience commands such as “Sit” or “Stay”.

Q3: Once my dog is trained and has been obeying my commands, will my dog have to continue to wear the collar receiver?

A: Your dog may need to wear the collar receiver from time to time for reinforcement.

Q4: Is the collar receiver waterproof?

A: Yes. The collar receiver is heavy duty and completely waterproof and submersible, specially designed to be worn outdoors day after day without problems.

Q5: Can I use the remote training system on aggressive dogs?

A: We do not recommend any of our products to be used on aggressive dogs. We recommend you to consult your local veterinarian or professional trainer to determine if your dog might be aggressive.

Q6: What do I do if my dog’s neck becomes red and irritated?

A: This condition is due to the contact points irritating the skin. Discontinue use of the collar receiver for a few days. If the condition persists beyond 48 hours, consult your local veterinarian. Once the skin returns to normal, replace collar receiver and monitor the skin condition closely.

Troubleshooting

Problem No. 1: If the collar receiver appears not to be working, try the following:

- Test the collar receiver. If red LED light flashes, please charge the receiver.
- If no Battery Status Bars shown on the transmitter, please charge the transmitter.
- Check the correct channel on the transmitter is used for the collar receiver.
- Re-perform the matching-up procedure (Step 4) between the collar receiver and transmitter handset and try to match up the collar receiver into a different channel.
- Adjust the collar strap to fit.
- Check the prongs are tightened.
- Ensure the contact points are in direct contact with your dog’s skin.
- If necessary, trim the dog’s hair or use longer probes to ensure proper skin contact. Never shave the dog’s neck.

- Use a stronger stimulation level. Please note that in very cold weather, you may need to use a slightly higher setting to achieve the same level of intensity.

Problem No. 2: The collar receiver cannot be matched up with the transmitter.

- Please make sure the collar receiver is switched on. When the collar receiver is in OFF mode, a red LED light will come up when the power button is pressed and held down, the collar receiver will not do the matching up successfully when it is OFF.
- Please make sure the power button on the collar receiver is held down firmly during the whole course of matching-up, so that the green indicator light on the collar receiver will come up and stay on, and later on start flashing on and off (not just flickering) once it has received the command signal sent from the transmitter handset.

Problem No. 3: The system doesn't have range, or the range has been significantly reduced.

Either you or the dog is shielded by a metal structure. Metal fences, chain link dog enclosures, screen doors, buildings, and other metal structures can affect the radio signal. Operate the Remote Trainer away from these structures.

You're experiencing temporary radio interference. Radio signals from nearby CBs and walkie talkies can reduce range. Wait a short while then try again, or move to another area.

Important: As this product is a wireless transmitting apparatus, you must NOT use the remote control system in places like petrol stations or hospitals where mobile phones are prohibited. For patients using heart pacemakers, please consult your doctor before using this device.